



US00D406055S

United States Patent [19]
Klawiter

[11] **Patent Number:** **Des. 406,055**
[45] **Date of Patent:** ****Feb. 23, 1999**

[54] **DISPLAY CONTAINER**
[75] Inventor: **Steven C. Klawiter**, Garner, N.C.
[73] Assignee: **Goodmark Foods, Inc.**, Raleigh, N.C.
[**] Term: **14 Years**
[21] Appl. No.: **61,912**
[22] Filed: **Nov. 1, 1996**
[51] **LOC (6) Cl.** **09-07**
[52] **U.S. Cl.** **D9/415**
[58] **Field of Search** D9/415, 418, 432,
D9/433, 346; 206/45.29, 45.28, 45.3, 45.24,
766, 736, 750; 229/172, 112, 164, 120.17,
152, 178

2,375,843 5/1945 Gottlieb .
2,771,986 11/1956 Bekoff .
2,812,852 11/1957 Samuels .
2,970,685 2/1961 Mayer 206/766
3,351,182 11/1967 Greer et al. .
3,417,861 12/1968 Levy .
3,729,091 4/1973 Davis .
4,011,943 3/1977 Galli et al. 206/45.28 X
4,448,303 5/1984 Beckenfeld 206/45.3 X
4,756,409 7/1988 Murray .
4,860,886 8/1989 Northrup et al. .
4,991,804 2/1991 Iannocci 206/45.24 X
5,337,821 8/1994 Fierek .

FOREIGN PATENT DOCUMENTS

434236 8/1935 United Kingdom .
940131 10/1963 United Kingdom .
2234959 2/1991 United Kingdom .
2252546 8/1992 United Kingdom .

OTHER PUBLICATIONS

Packaging Catalog, pp. 56, 58 & 60, 1940.

Primary Examiner—Prabhakar G. Deshmukh
Attorney, Agent, or Firm—Bell Seltzer Intellectual Property
Law Group of Alston & Bird LLP

[57] **CLAIM**

The ornamental design for a display container, as shown and described.

DESCRIPTION

FIG. 1 is a top, right, front perspective view of a display container showing the design of the present invention; FIG. 2 is a right side view thereof, which is a mirror image of the left side thereof; FIG. 3 is a front view thereof; FIG. 4 is a rear view thereof; FIG. 5 is a top view thereof; FIG. 6 is a bottom view thereof. FIG. 7 is a top, right, front perspective view of an alternative embodiment of a display container having a design of the present invention. The corresponding views of the second embodiment (FIG. 7) are same as disclosed in FIGS. 2-6 of the first embodiment with the exception of the dangling flag configuration.

1 Claim, 4 Drawing Sheets

[56] **References Cited**
U.S. PATENT DOCUMENTS

D. 70,576 7/1926 Peruzzi D9/415
267,271 11/1882 Snow .
D. 304,644 11/1989 Silcox D9/415 X
D. 387,979 12/1997 Dolan D9/415
414,450 11/1889 Schwartz .
476,765 6/1892 Knapp .
527,688 10/1894 Hershheim .
529,760 11/1894 Stevens .
937,173 10/1909 Pfeiffer .
1,104,253 7/1914 Dunphee .
1,403,869 1/1922 Reid .
1,452,257 4/1923 Singer et al. .
1,599,983 9/1926 Bergstein .
1,648,280 11/1927 Pitts .
1,743,502 1/1930 Tanner .
1,755,731 4/1930 Guyer .
1,799,656 4/1931 Tinsley .
1,800,550 4/1931 Mahoney, Jr. et al. .
1,817,045 8/1931 Tanner .
1,889,625 11/1932 Barter .
1,902,262 3/1933 Powell 206/45.29
2,027,079 1/1936 Weiss 206/45.29 X
2,054,596 9/1936 Ford .
2,119,789 6/1938 Krout .
2,168,240 8/1939 Roberts .
2,178,091 10/1939 Weiss 206/45.3
2,209,657 7/1940 Martin .
2,330,927 10/1943 Rous et al. 206/45.29
2,337,596 12/1943 Garipey .

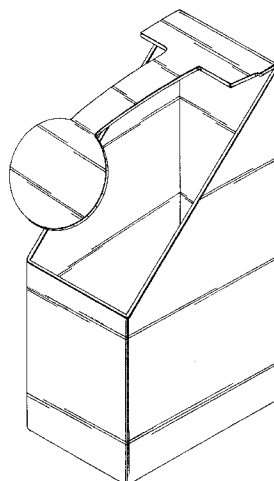

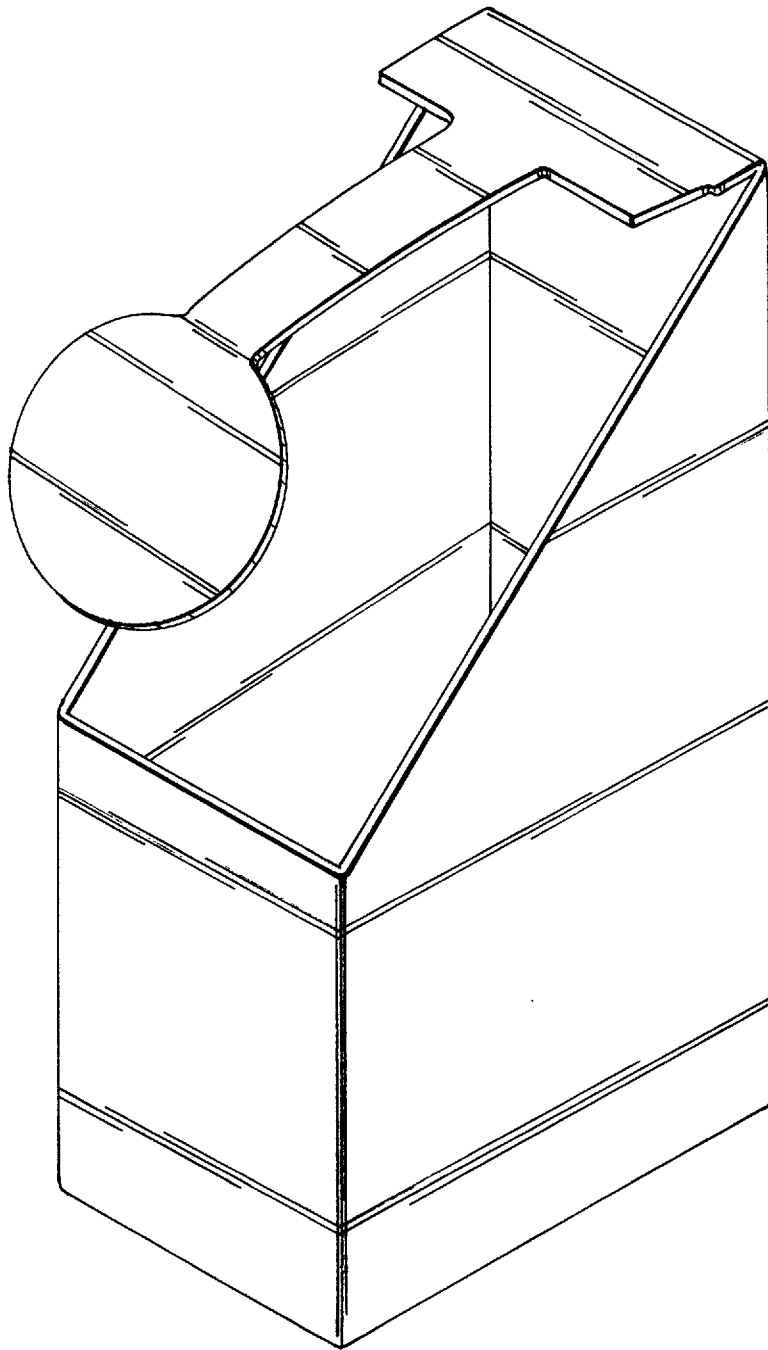

Fig. 1

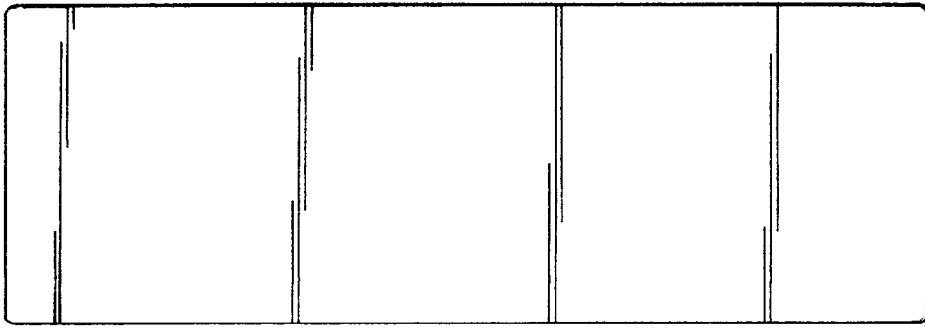

Fig. 4

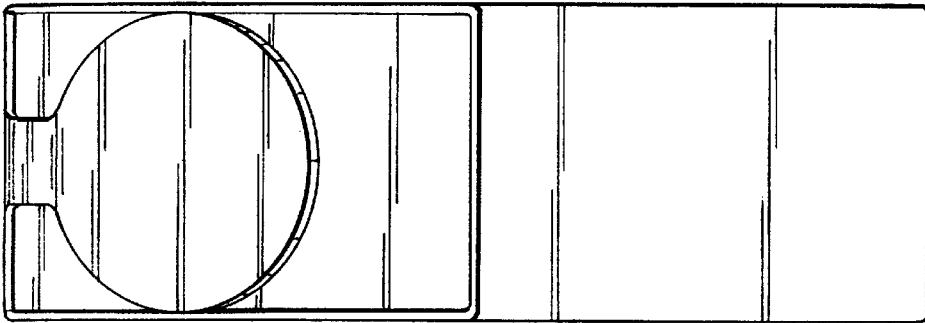

Fig. 3

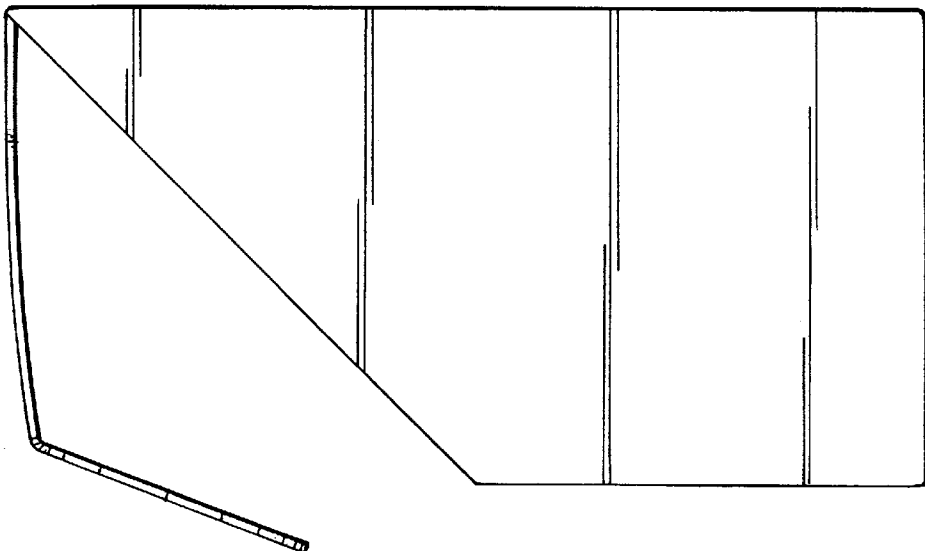

Fig. 2

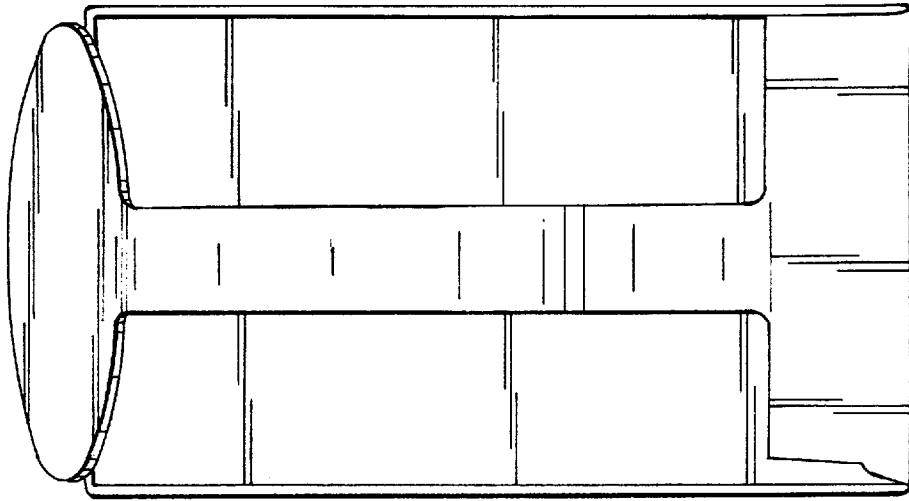

Fig. 5

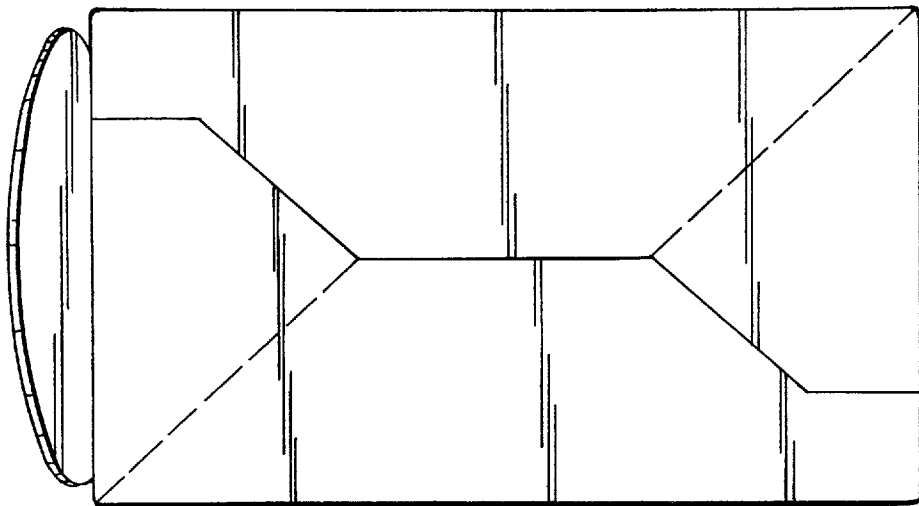

Fig. 6

Fig. 7

